

Sistema minimalista de correderas con ruptura de puente térmico
Minimalist sliding system with thermal break
Système coulissant minimaliste avec rupture thermique

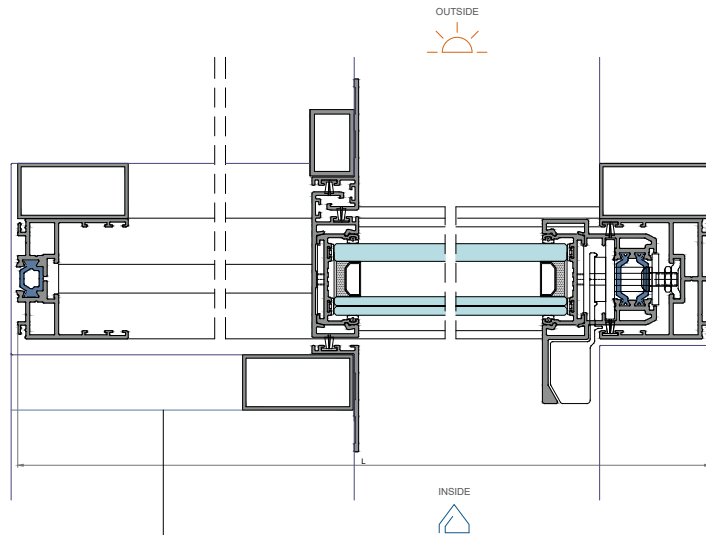

INV36
_CC

VENTANA CORREDERA 1 HOJA POCKET 1 RAIL | 1 LEAF POCKET WINDOW 1 RAIL | FENÊTRE 1 VANTAIL POCKET 1 RAIL



PANEL ISOTÉRMICO (CLIENTE)
ISOTHERMAL PANEL (CLIENT)
PANNEAU ISOTHERME (CLIENT)

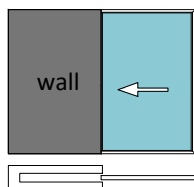
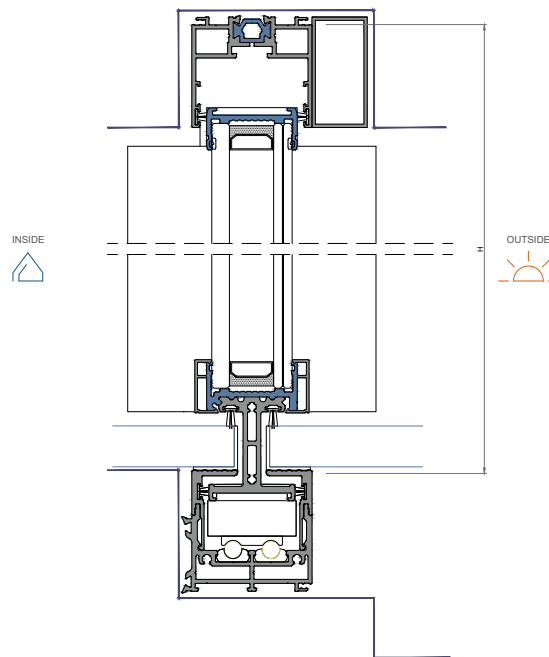

VENTANA CORREDERA 2 HOJAS POCKET 1 RAIL | 2 LEAVES POCKET WINDOW 1 RAIL | FENÊTRE 2 VANTAUX POCKET 1 RAIL

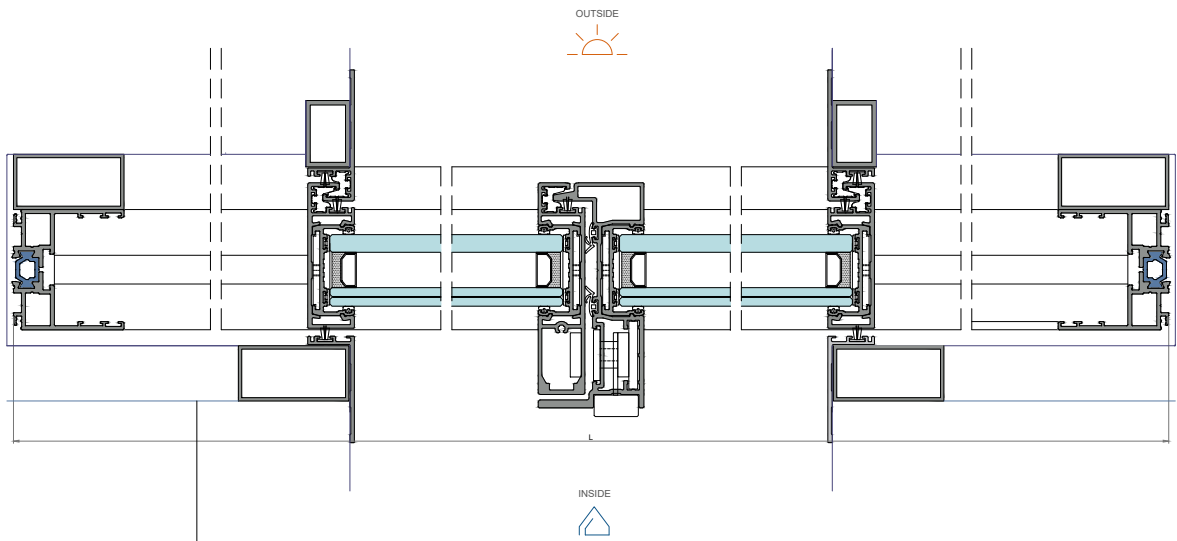

PANEL ISOTÉRMICO (CLIENTE)
ISOTHERMAL PANEL (CLIENT)
PANNEAU ISOTHERME (CLIENT)

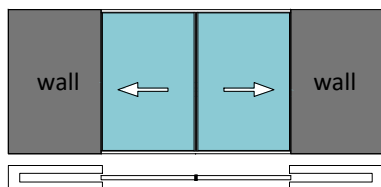
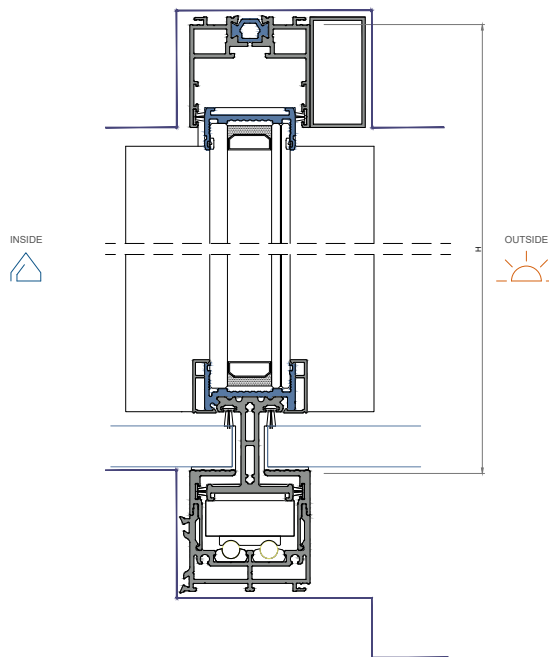

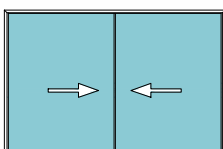
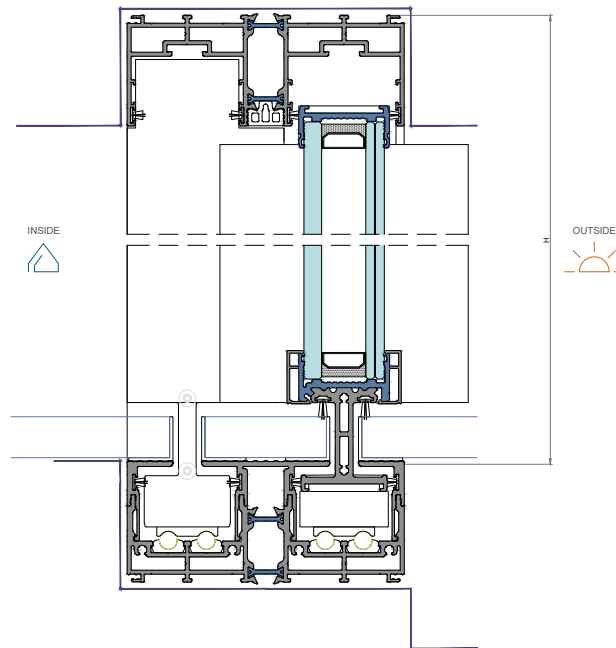
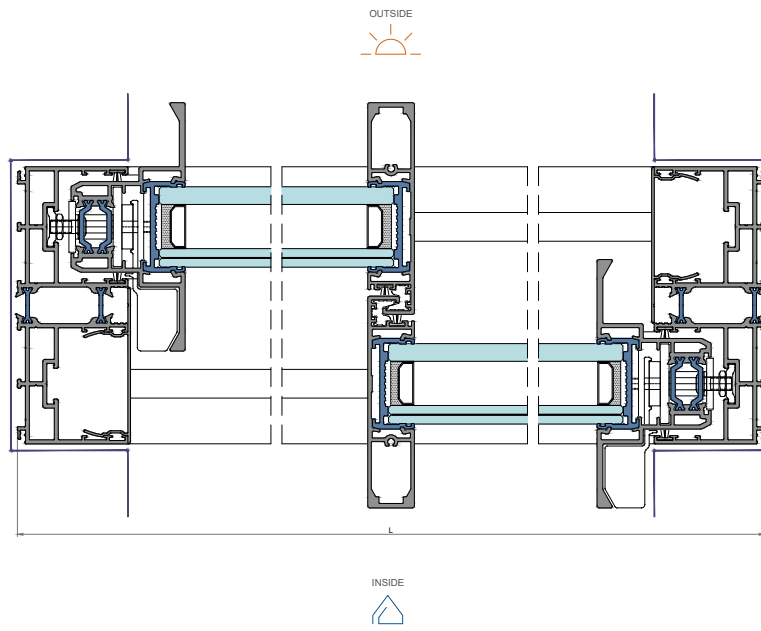

VENTANA CORREDERA 2+2 HOJAS 2 RAIL ESQUINA 90° | 2+2 LEAVES WINDOW 2 RAIL CORNER 90° | FENÊTRE 2+2 VANTAUX 2 RAIL ANGLE 90°

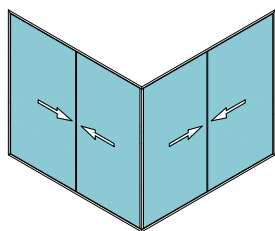
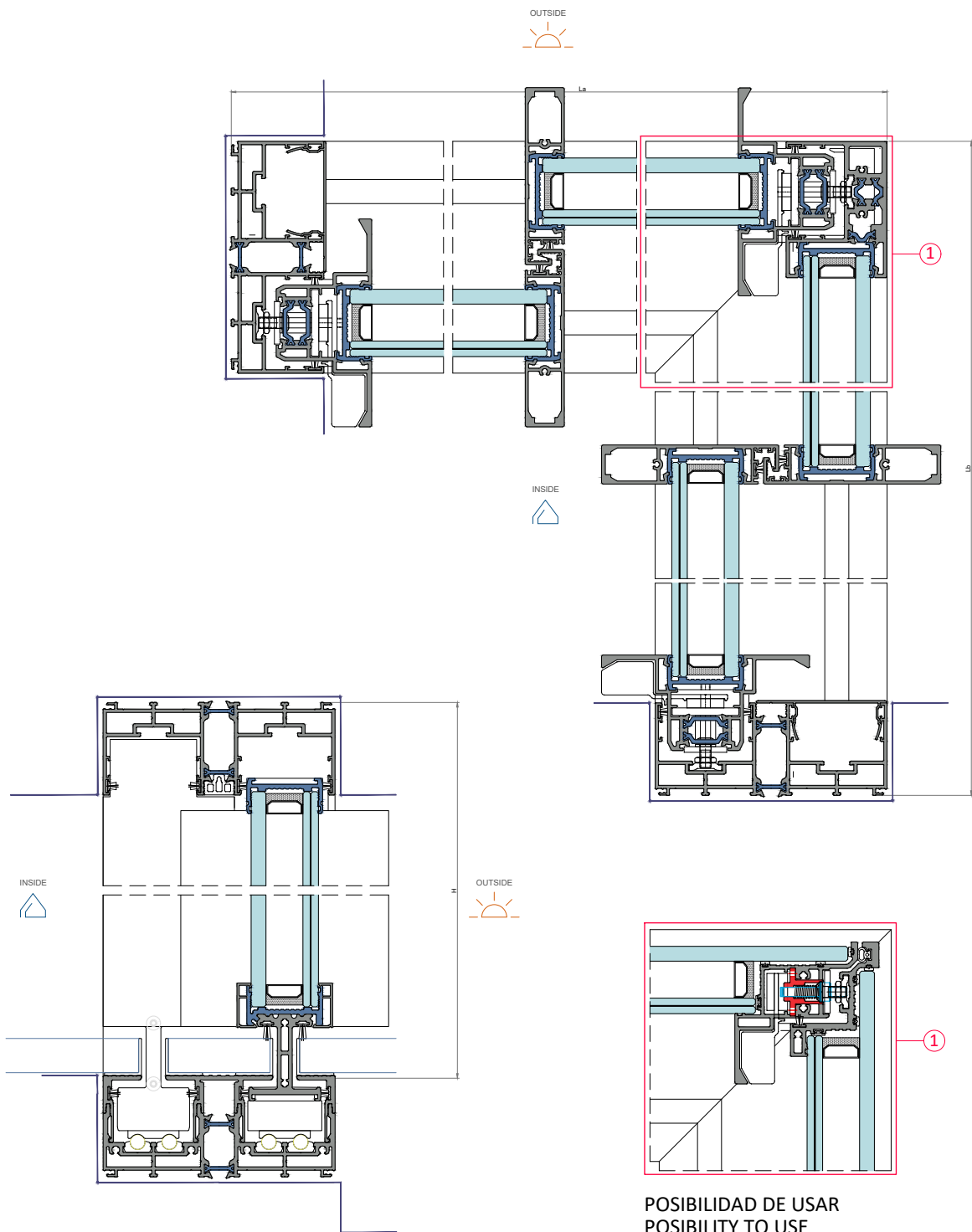

VENTANA CORREDERA 3 HOJAS 3 RAIL | 3 LEAVES WINDOW 3 RAIL | FENÊTRE 3 VANTAUX 3 RAIL

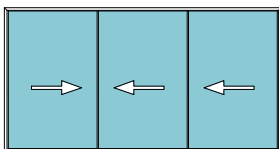
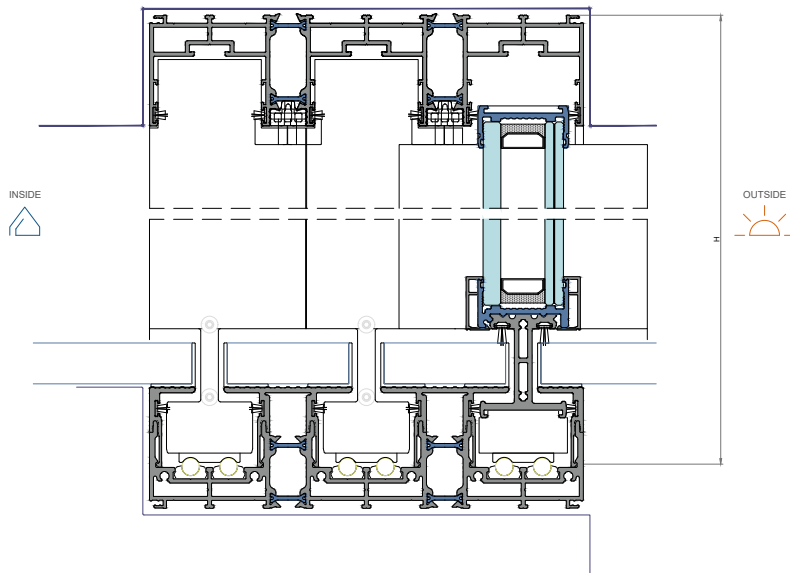
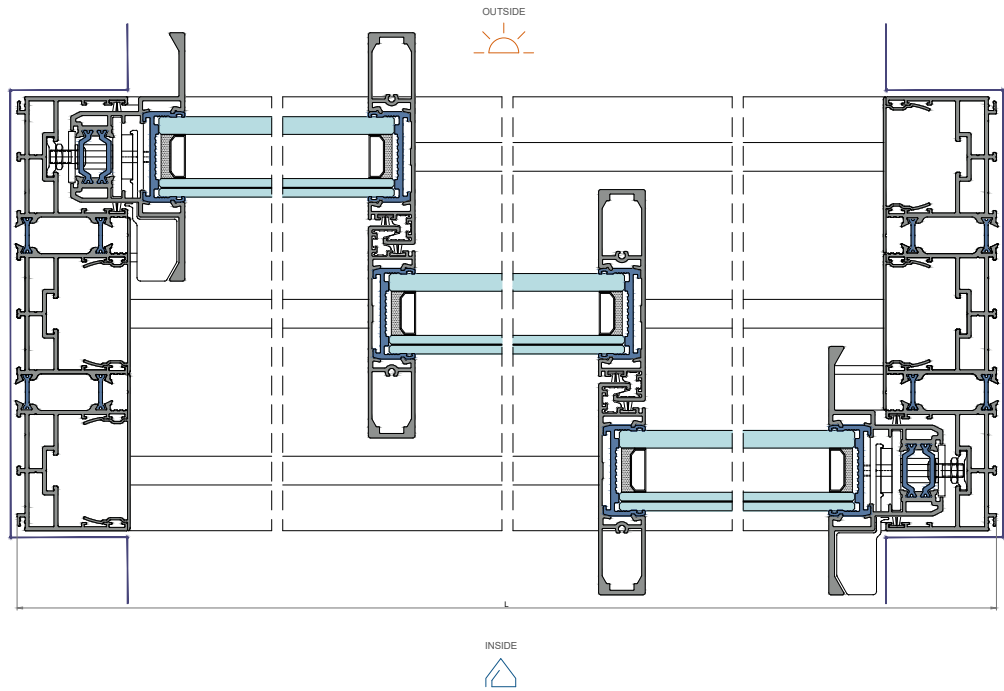

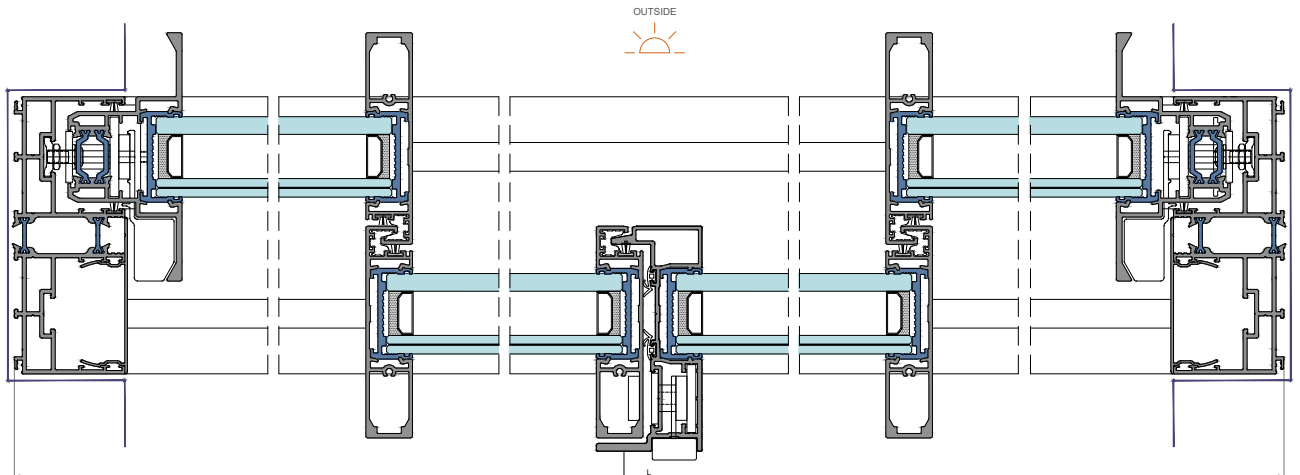

APERTURA CENTRAL 47mm
CENTRAL OPENING 47mm
OUVERTURE CENTRALE 47mm

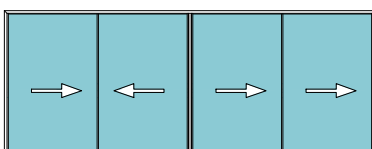
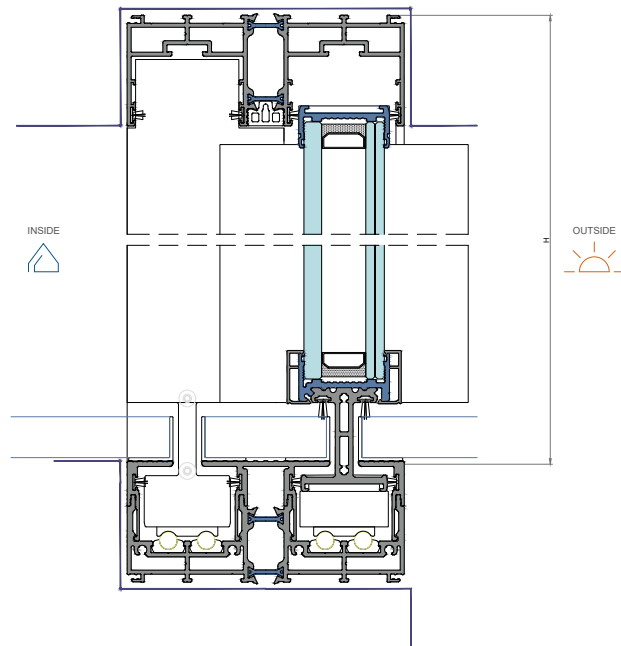

VENTANA CORREDERA 4 HOJAS 2 RAIL | 4 LEAVES WINDOW 2 RAIL | FENÊTRE 4 VANTAUX 2 RAIL

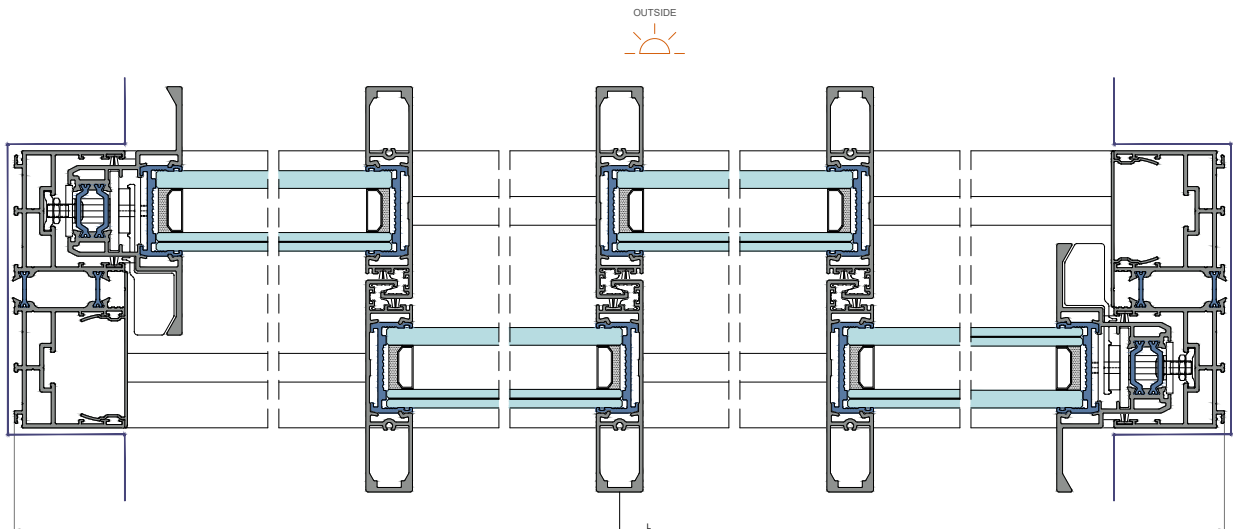

APERTURA CENTRAL 20mm
CENTRAL OPENING 20mm
OUVERTURE CENTRALE 20mm

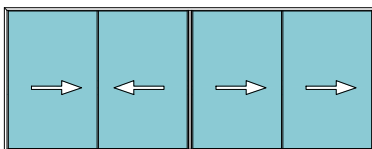
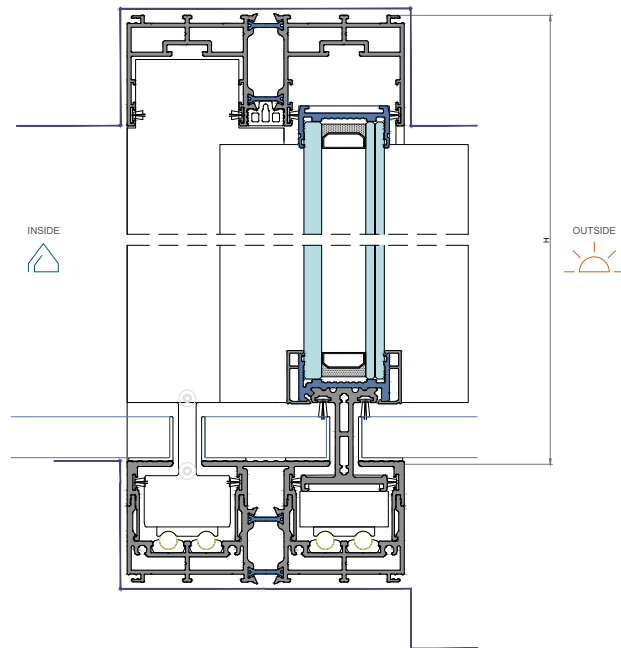

VENTANA CORREDERA 4 HOJAS 4 RAIL | 4 LEAVES WINDOW 4 RAIL | FENÊTRE 4 VANTAUX 4 RAIL

