

Sistema minimalista de correderas con ruptura de puente térmico  
Minimalist sliding system with thermal break  
Système coulissant minimaliste avec rupture thermique

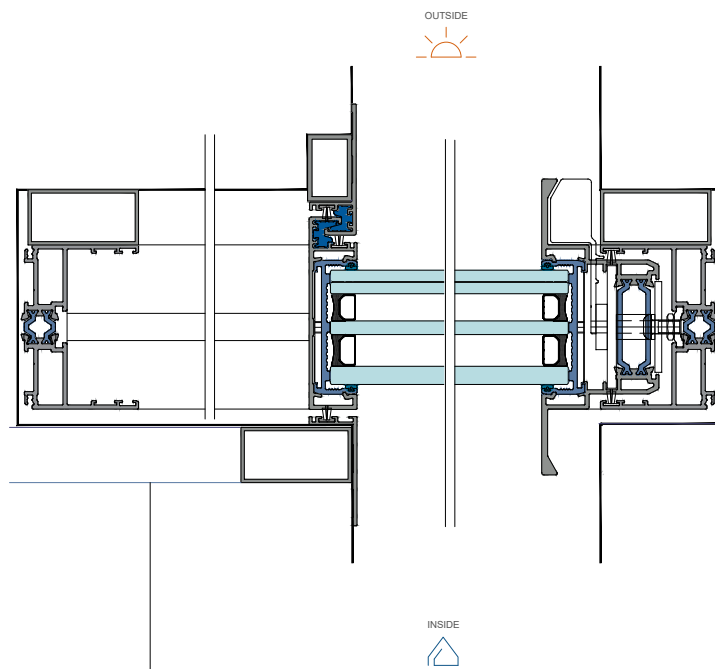

INV54  
\_CC

VENTANA CORREDERA 1 HOJA POCKET 1 RAIL | 1 LEAF POCKET WINDOW 1 RAIL | FENÊTRE 1 VANTAIL POCKET 1 RAIL



PANEL ISOTÉRMICO (CLIENTE)  
ISOTHERMAL PANEL (CLIENT)  
PANNEAU ISOTHERME (CLIENT)

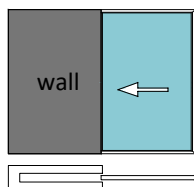
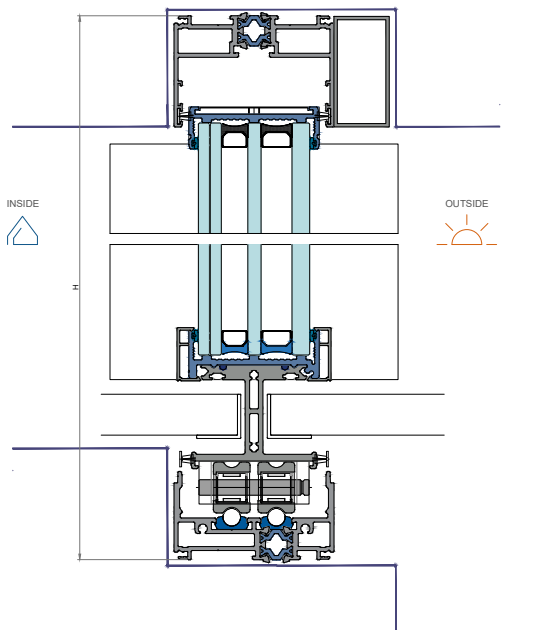

VENTANA CORREDERA 2 HOJAS POCKET 1 RAIL | 2 LEAVES POCKET WINDOW 1 RAIL | FENÊTRE 2 VANTAUX POCKET 1 RAIL

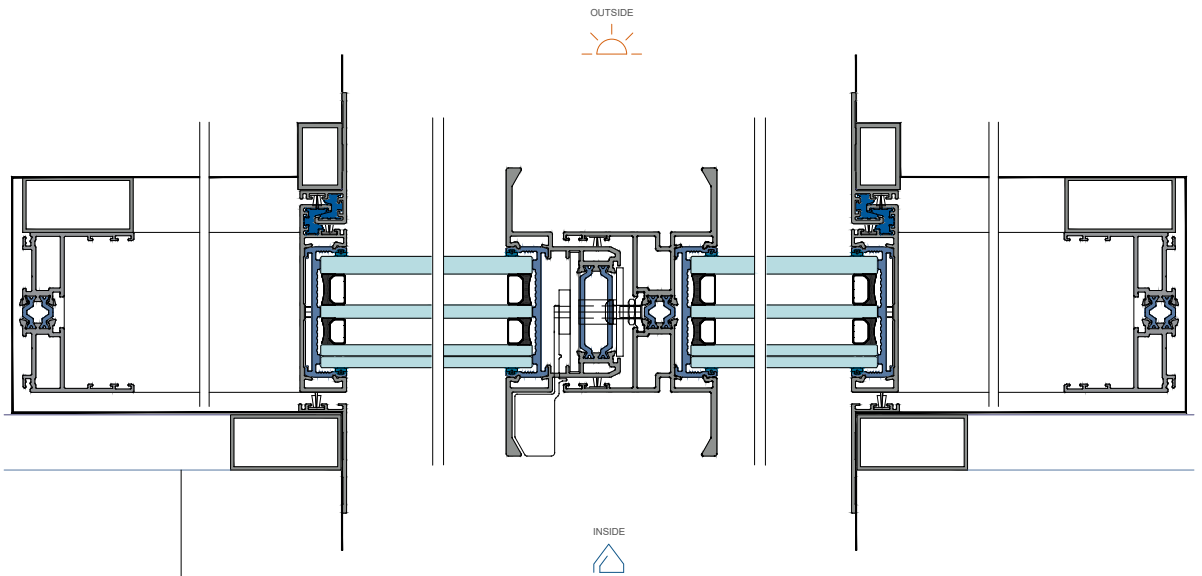

PANEL ISOTÉRMICO (CLIENTE)  
ISOTHERMAL PANEL (CLIENT)  
PANNEAU ISOTHERME (CLIENT)

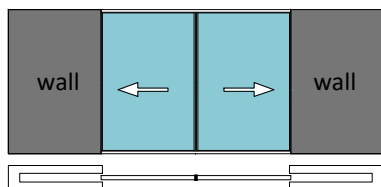
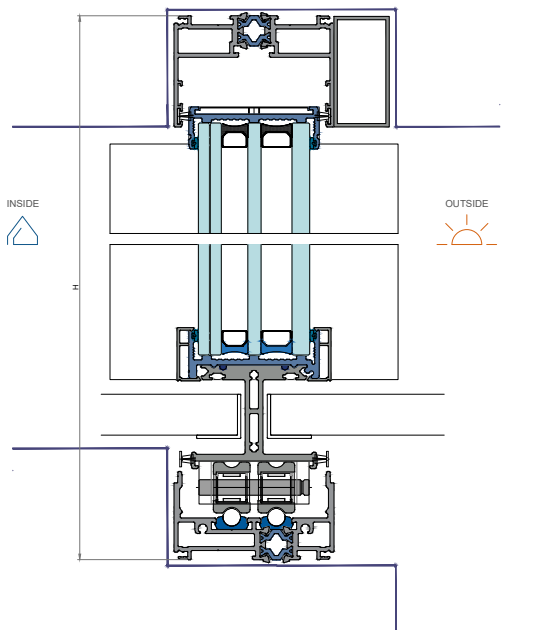

VENTANA CORREDERA 2 HOJAS BIRAIL | 2 LEAVES WINDOW BIRAIL | FENÊTRE 2 VANTAUX BIRAIL

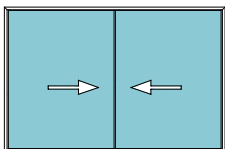
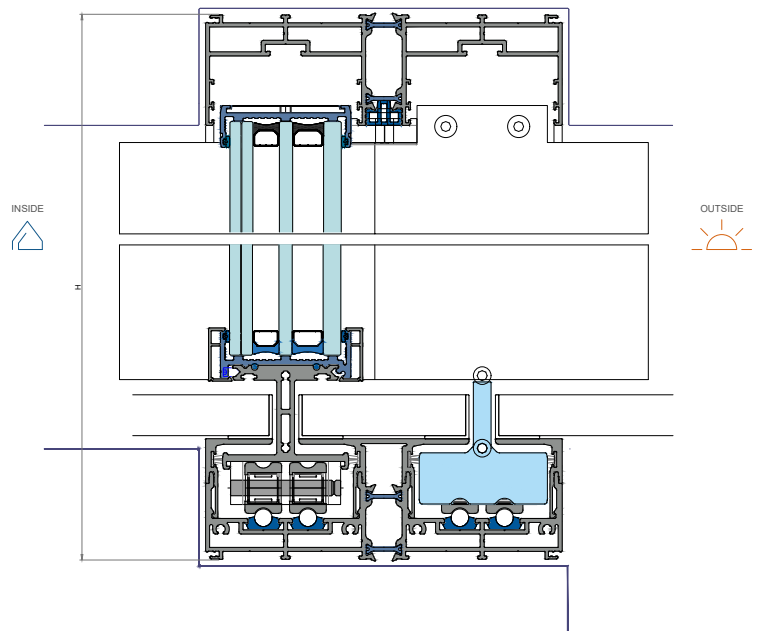
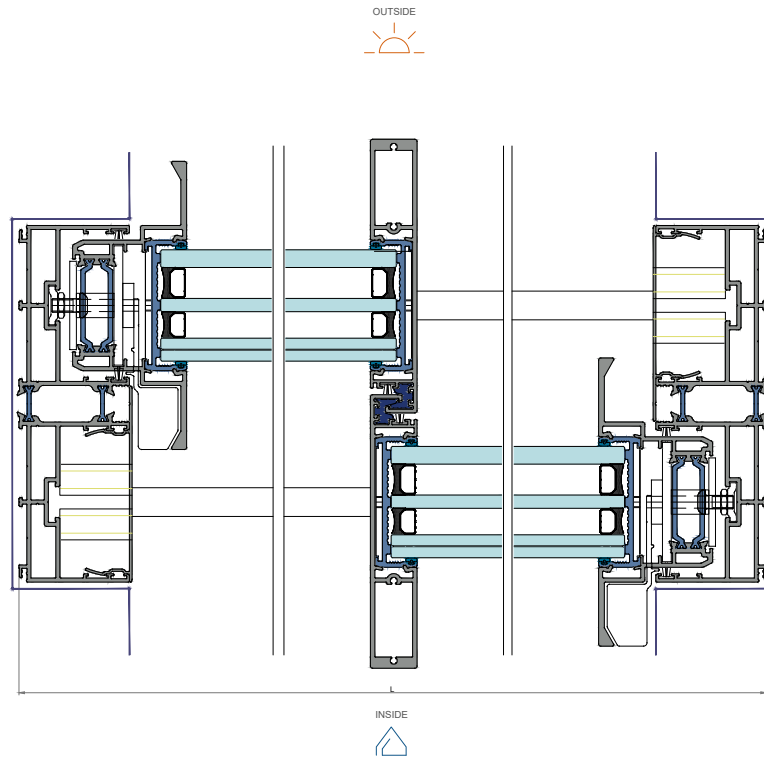



VENTANA CORREDERA 3 HOJAS TRIRAIL | 3 LEAVES WINDOW TRIRAIL | FENÊTRE 3 VANTAUX TRIRAIL

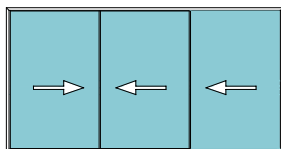
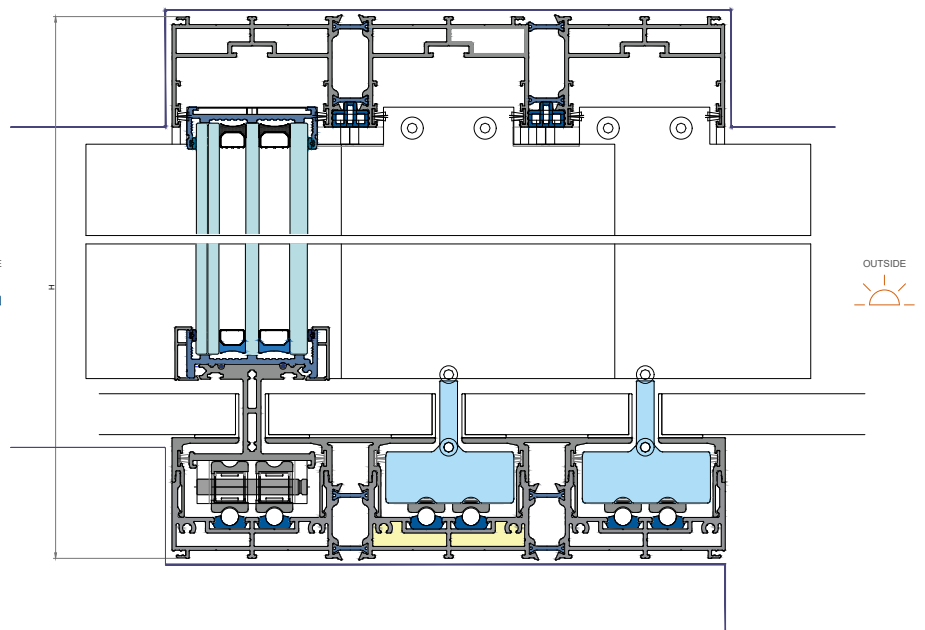
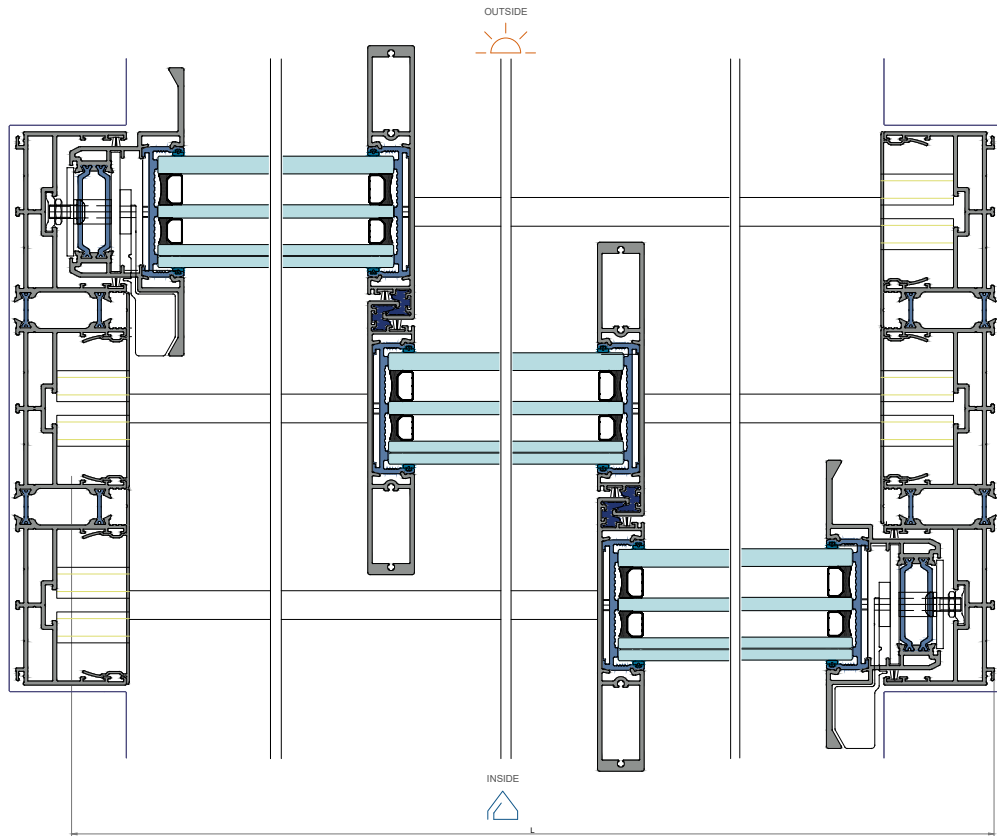

VENTANA CORREDERA 4 HOJAS 2 RAIL | 4 LEAVES WINDOW 2 RAIL | FENÊTRE 4 VANTAUX 2 RAIL

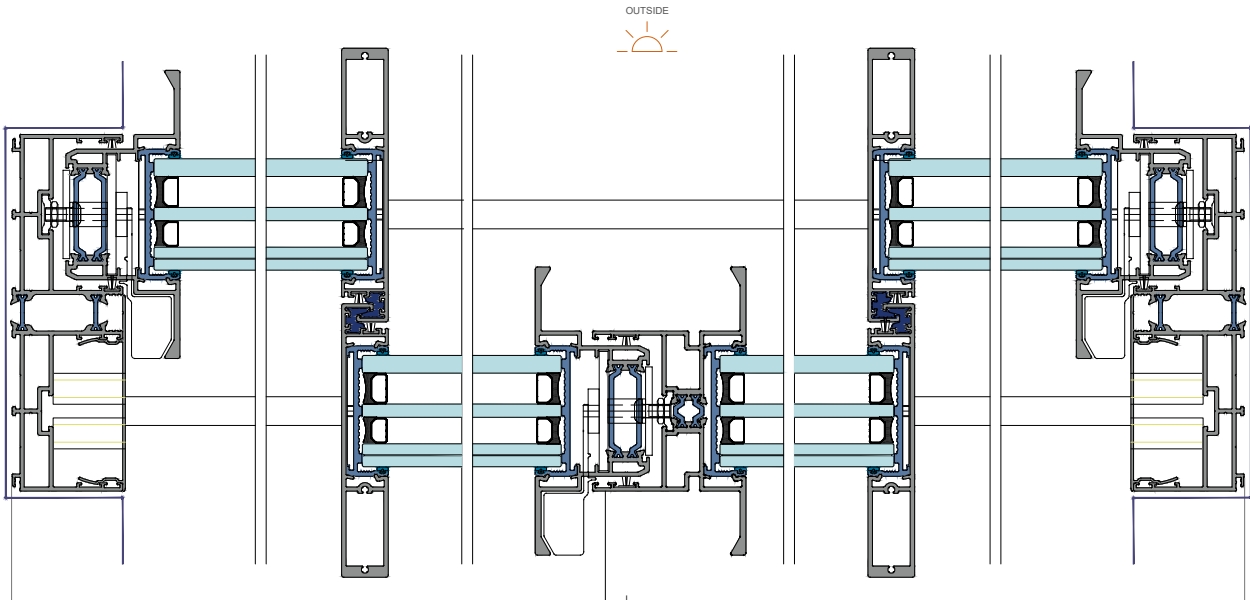

APERTURA CENTRAL 95mm  
CENTRAL OPENING 95mm  
OUVERTURE CENTRALE 95mm

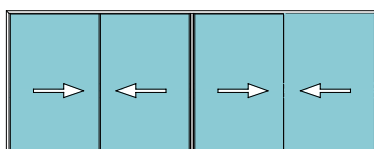
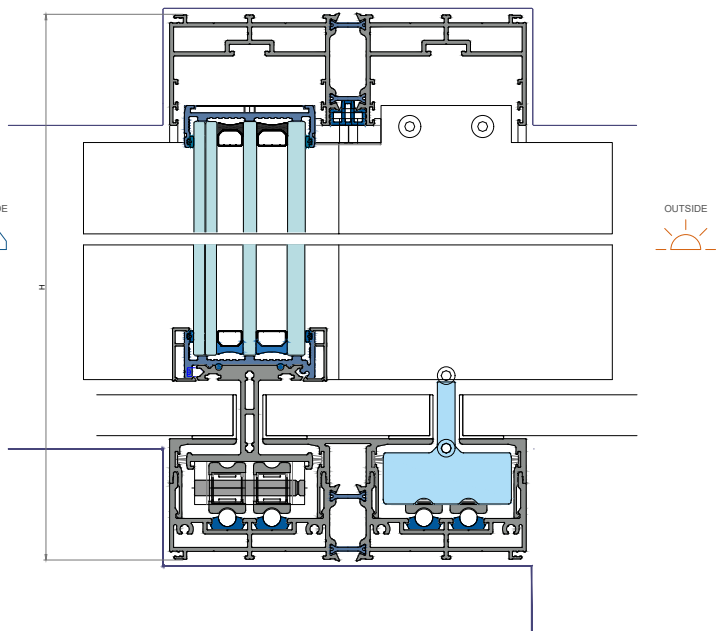

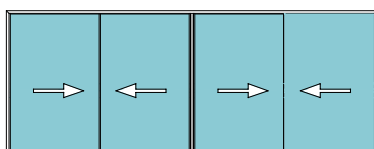
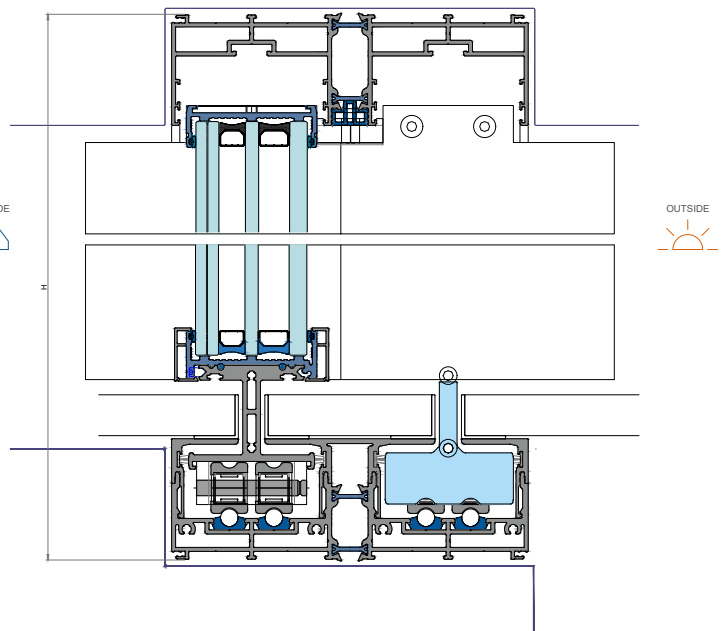
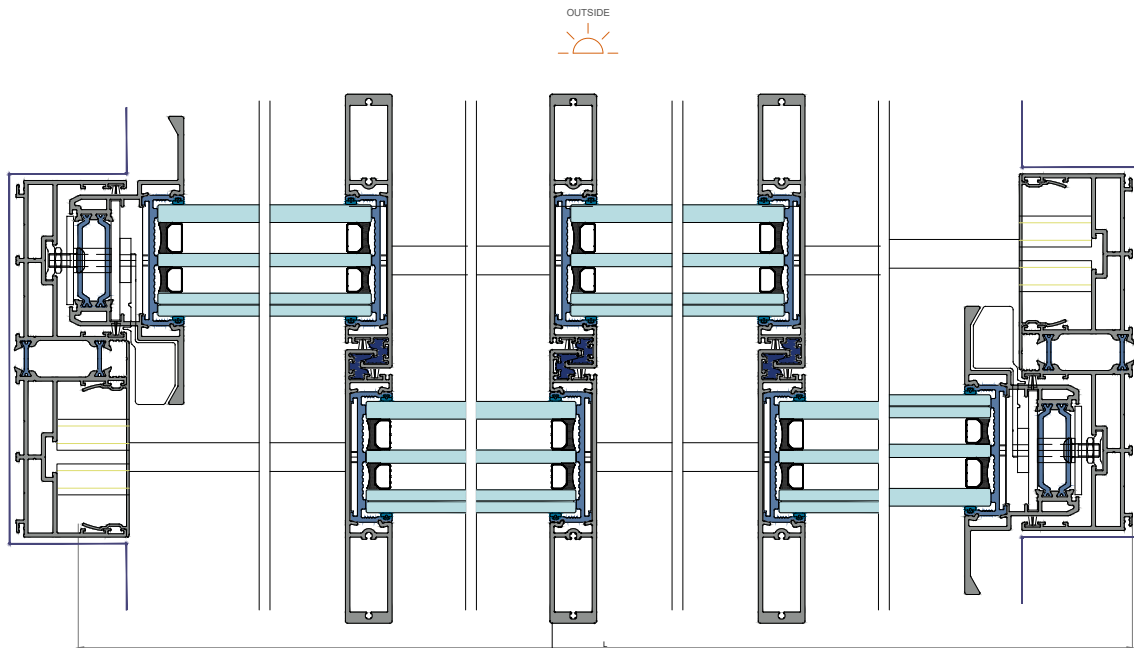

VENTANA CORREDERA 2H POCKET BIRAIL+3H TRIRAIL ESQUINA 90° | 2 LEAVES POCKET WINDOW BIRAIL+3 LEAVES TRIRAIL CORNER 90°  
 FENÊTRE 2 VANTAUX POCKET BIRAIL+3 VANTAUX TRIRAIL ANGLE 90°

PANEL ISOTÉRMICO (CLIENTE)  
 ISOTHERMAL PANEL (CLIENT)  
 PANNEAU ISOTHERME (CLIENT)

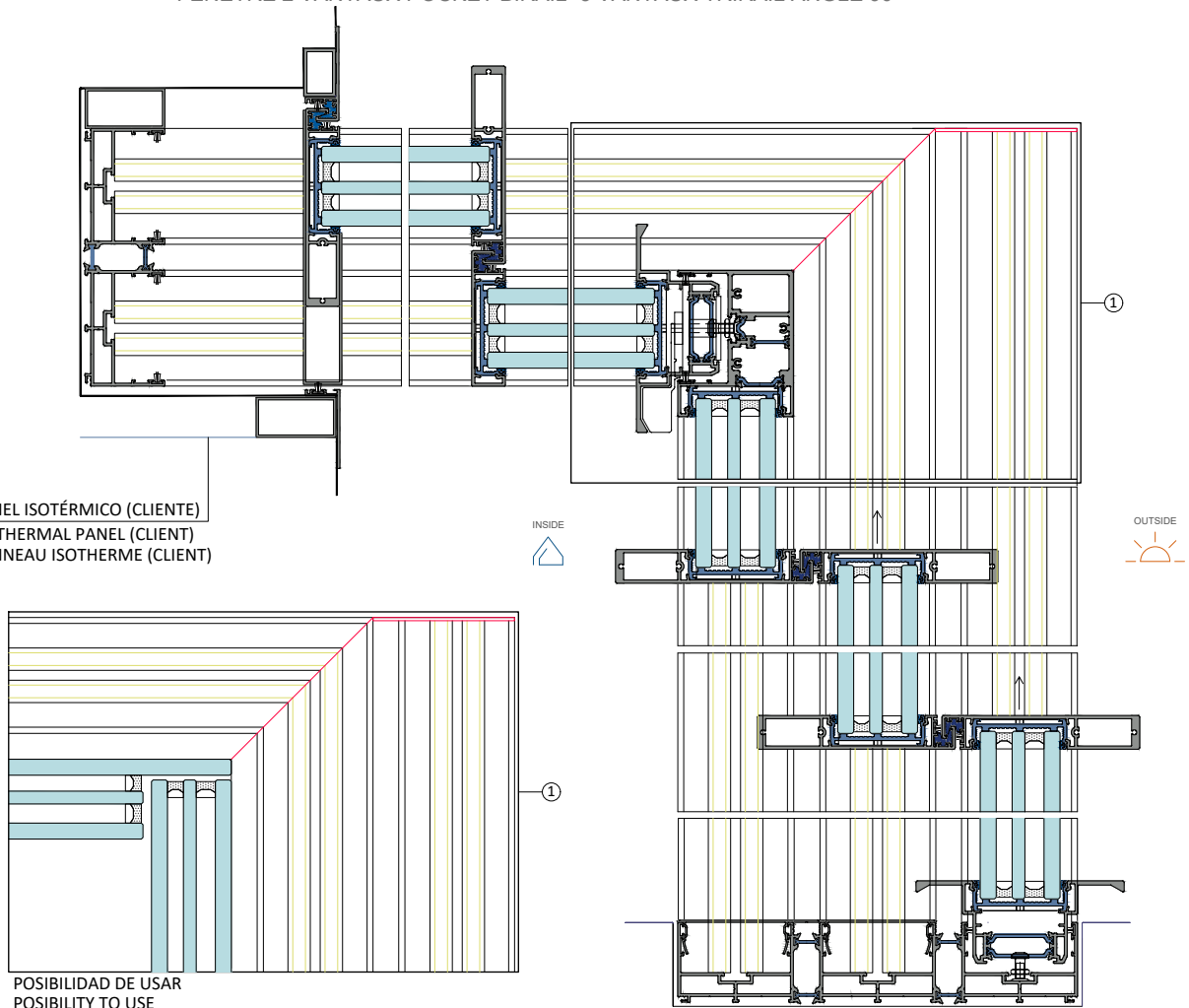

POSIBILIDAD DE USAR  
 POSSIBILITY TO USE  
 POSSIBILITÉ 'D UTILISER

